

PARTS DIAGRAM & PARTS LIST

ENDURA 45 - 45 LBS THRUST - 12 VOLT - 36" SHAFT

This page provides Minn Kota® WEEE compliance disassembly instructions. For more information about where you should dispose of your waste equipment for recycling and recovery and/or your European Union member state requirements, please contact your dealer or distributor from which your product was purchased. Tools required, but not limited to: flat head screw driver, Phillips screw driver, socket set, pliers, wire cutters.

Endura 45 Parts Diagram

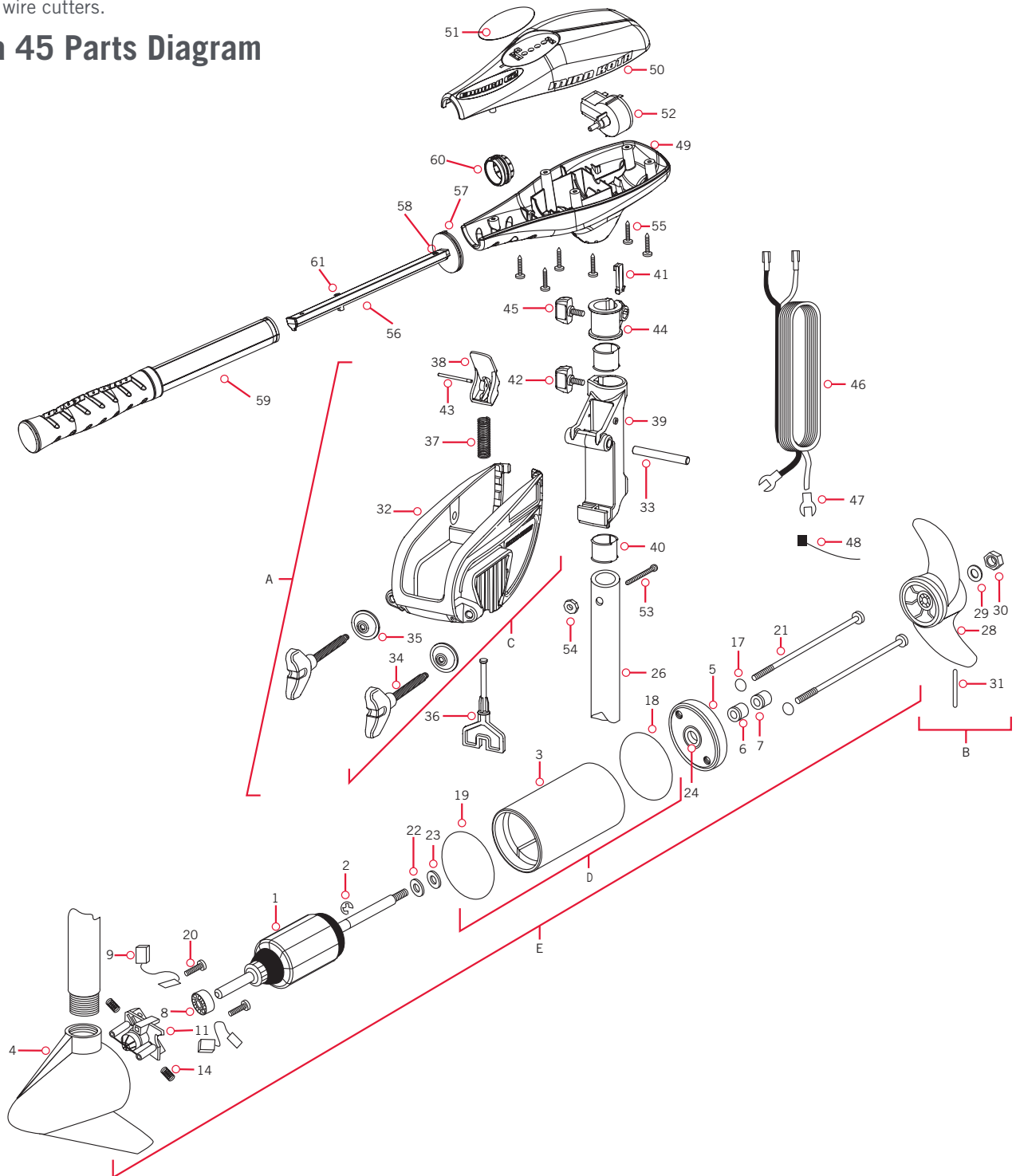

PARTS DIAGRAM & PARTS LIST

› Endura 45 Parts List

Assembly	Part #	Description	Quantity
A	2771818	BRACKET & HINGE ASSEMBLY (INCLUDES 32-43)	1
B	1378121	PROPELLER KIT (INCLUDES 28-31)	1
C	2771910	BRACKET ASSEMBLY (INCLUDES 32, 34, 35)	1
D	2883460	SEAL AND O-RING KIT	1
E	2069285	MOTOR ASSEMBLY 12 V 3.25 5SP	1
Item	Part #	Description	Quantity
1	2-100-202	ARMATURE ASSEMBLY 12V 3.25	1
2	788-015	RETAINING RING	1
3	2-200-079	HOUSING ASSEMBLY CENTER 3.25 TXT	1
4	2-300-132	BRUSH END HOUSING ASSEMBLY 3.25 SP.CO	1
5	2-400-187	PLAIN END HOUSING ASSEMBLY 3.25	1
6	880-003	SEAL	1
7	880-006	SEAL W/SHIELD	1
8	140-010	BALL BEARING	1
9	188-052	BRUSH ASSEMBLY	2
11	738-030	BRUSH PLATE W/HOLDER 3.25	1
14	975-032	COMPRESSION SPRING	2
17	701-007	O-RING — THRU BOLT	2
18	701-039	O-RING	1
19	701-041	O-RING	1
20	830-001	SCREW — SELF THREAD #8-32X1.7	2
21	830-078	THRU BOLT #8-32X8.0	2
22	990-067	WASHER — STEEL THRUST	1
23	990-070	WASHER — NYLATRON	2
24	144-049	FLANGE BEARING (SERVICE ONLY)	1
26	2032046	36" COMPOSITE TUBE	1
28	2061122	PROPELLER 3.25 HUB DIA	1
29	2151726	WASHER — 5/16 STD SS	1
30	2053101	NUT — PROP NYLOCK (MED) SS	1
31	2092600	DRIVE PIN	1

Item	Part #	Description	Quantity
32	✱	BRACKET	1
33	2060510	HINGE PIN	1
34	✱	SCREW — CLAMP	2
35	✱	WASHER — CLAMP SCREW	2
36	2063605	PLASTIC T-BAR	1
37	2062706	T-BAR SPRING	1
38	2067201	TILT BLACK LEVER	1
39	2061810	PLASTIC HINGE	1
40	2037301	HINGE BUSHING	2
41	2062800	SNAP-IN TENSION BLOCK	1
42	2011385	SCREW — TENSION/KNOB	1
43	2060515	TILT LEVER PIN	1
44	2061520	DEPTH COLLAR	1
45	2011365	SCREW — COLLAR/NEW KNOB	1
46	2050610	LEADWIRE (10 GA) W/SPADE TERM	1
47	2020703	SPADE TERMINAL 14GA HD	2
48	2256300	TIE WRAP	1
49	2062515	CONTROL BOX	1
50	2060215	CONTROL BOX COVER	1
51	2065702	DECAL COVER ENDURA C2 45	1
52	2064028	SWITCH — FWD/REV 5 SP	1
53	2033401	SCREW — #10-24 X 1-3/4	1
54	2013110	NUT — 10-24 HEX	1
55	2012100	SCREW — #8-18 X 5/8	6
56	2990919	INNER HANDLE ASSEMBLY	1
57	2060405	HANDLE PIVOT	1
58	2012104	SCREW — #6 X 1/2" SS	1
59	2990928	OUTER HANDLE ASSEMBLY	1
60	2060009	FRONT BEARING	1
61	2882726	BALL DETENT, RTNR SPRNG ASM KIT	1

✱ This part is included in an assembly and cannot be ordered individually.

▲ Not shown on Parts Diagram.